



AFINIA 3D™



H800+ 3D Printer

Version 1.1

TABLE OF CONTENTS

Safety Precautions	5
Protecting the Printer	5
Overview	6
Unpacking the Afinia H800+ 3D Printer	8
The Print Head	9
The Control Buttons	9
Installing the Afinia H800+ 3D Printer	10
Driver and Software Installation	10
Installing the Printer	10
Loading the Filament Spool	11
Preparing the Platform	12
Software and Printer Settings	13
Starting the Studio Program	13
Changing the Language	14
Selecting the Printer	14
Wi-Fi Setup	14
Version Management	15
Getting Ready to Print	16
The Calibration Window	16
Leveling the Print Platform	16
Platform Calibration	17
Nozzle Height Calibration	18
The Maintenance Window	19
Adding Customized Material	19
Loading a 3D Model	20
Basic Printing	21
Printing a 3D Model	21
Infill Types	21
Print Progress	22
Pausing or Stopping a Print	22
Advanced Printing	23
Loading Multiple Models	23
Right-click Menu	23
Model Wheel, Menu Level 1	24
Rotation	24
Movement	25
Scaling	26
Auto Placement	26
Undo	26
Views	27
Model Wheel, Menu Level 2	27
Fix	27
Merge	28
Mirror	28
Delete	28
Save	28
Reset to Default	28
Undo	28
Return to Main Menu	28

Advanced Print Settings.....	29
Part Settings	29
Support Settings	29
Other Settings	30
Status Indicator.....	31
Filament Check	31
Power Failure Recovery.....	31
Converting a 2D Picture into a 3D Model	32
Model Removal	33
Maintenance	34
Changing the Filament.....	34
Cleaning the Nozzle	35
Removing / Changing the Nozzle.....	35
Cleaning the Extruder Gear	36
Cleaning the Platform.....	37
Lubrication of Extruder Rails	37
Changing the HEPA Filter	37
Spare parts	37
Tips & Tricks	38
Troubleshooting.....	40
Specifications	41
Technical Support.....	42

Afinia 1-Year Limited Warranty

Below is the one-year limited warranty included with this Afinia product. Afinia prides itself on its outstanding product line and its technical support. If for some reason, your product fails, Afinia, a division of Microboards Technology, LLC, stands behind its warranties and assures you the best service possible in a quick and timely manner.

Afinia warrants to the original purchaser that this product is free from defects in material and workmanship. Afinia will for one year, at its option, repair or replace at no charge for parts and labor from the date you purchased the product from an authorized Afinia reseller. Nozzles and Cell/Perf Boards are warranted for ninety (90) days.

- Warranty registration must be completed within 30 days of receipt of the product in order to validate the warranty.
- Afinia, a division of Microboards Technology, LLC, reserves the right to determine the validity of all warranty claims.
- Warranty is void if the product serial number has been altered or removed.
- Warranty is void if the product has been misused or damaged or if evidence is present that the product was altered, modified, or serviced by unauthorized service people.

The above stated warranty is exclusive and replaces all other warranties, express or implied, including those of merchantability and fitness for a particular purpose. Afinia, a division of Microboards Technology, LLC, will not be liable for any other damages or loss, including incidental or consequential damages and loss of profits or revenues from whatever cause, including breach of warranty or negligence.

This product has been thoroughly tested and inspected at the factory prior to shipment. Nevertheless, inspect your product completely for any damage or loss of parts that may have occurred during shipment. Notify the delivering carrier promptly if damage claims are to be filed.

Afinia reserves the right to modify or update its product without obligation to replace any equipment delivered prior to any such change.





To register your warranty, please visit www.afia.com/register

Safety Precautions

Please read this section carefully before using the printer.

- The printer can only be used with the power adapters supplied by this company, or the product may be damaged, with a risk of fire.
- To avoid burning or model deformation, do not touch the model, nozzle, or the platform by hand or any other part of the body while the printer is working or immediately after it has finished printing.
- Protective glasses should always be worn when removing support material, especially PLA.
- There is a slight smell from ABS when it is being extruded. A well-ventilated room is recommended; however when printing, keep the printer away from any drafts as this can affect the warping of ABS prints.
- When ABS is burnt it releases toxic fumes. Never set the nozzle temperature high enough to burn the material.

The following classifications are used in this manual:

	CAUTION: Indicates a potentially hazardous situation which, if not avoided, may result in minor or moderate injury.
	WARNING: Indicates a potentially hazardous situation which, if not avoided, may result in serious injury.
	GLOVES: When performing certain maintenance procedures, the machine may be hot and gloves are required to avoid burns.
	SAFETY GLASSES: Wear safety glasses to avoid injury to your eyes.

Protecting the Printer

- The printer must not be exposed to water or rain, or damage may occur.
- Do not shut down the Afinia H800+ 3D System or pull out the USB cable when loading a digital model or the model data may be lost.
- When using the “Extrude” function, keep at least 50mm between the nozzle and the platform. If too close, the nozzle may get blocked.
- The printer is designed to work properly at an ambient temperature of between 60°F and 85°F and humidity of between 20% and 50%. Operating outside these limits may result in low quality models.

Overview

The Afinia H800+ was designed specifically for educators and professionals looking for fast, hassle-free 3D printing with exceptional quality. The Afinia H800+ boasts a host of features, from Wireless Connectivity, user-friendly software and automatic leveling, to paper-thin layer HD resolution with a heated build platform and an out-of-filament sensor. Everything about this printer is geared towards creating high standard professional 3D models.

Print a working bearing in one design, make a part for a dishwasher or just unleash your creativity and bring your designs to life with your new Afinia H800+.



The Studio software sends the print data from a Mac or PC to the Printer either over a single USB cable or by wireless connection. The Extruder delivers the Filament from the Spool into the Nozzle, which heats the filament to printing temperature and deposits it on the Platform.

The Afinia H800+ with HEPA filter is packed with advanced technologies in a stylish and robust design.

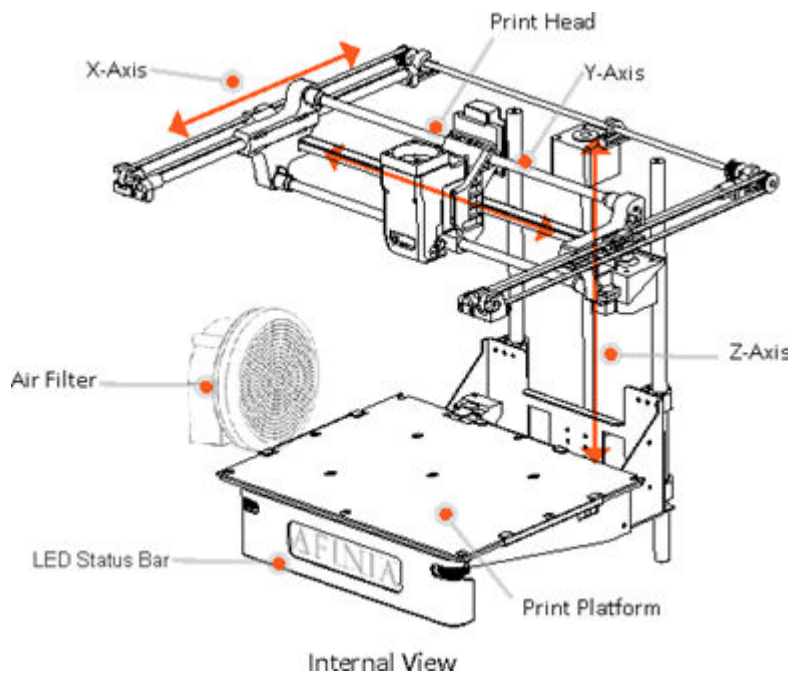
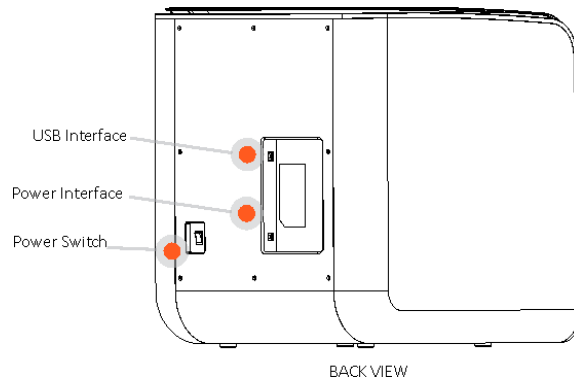
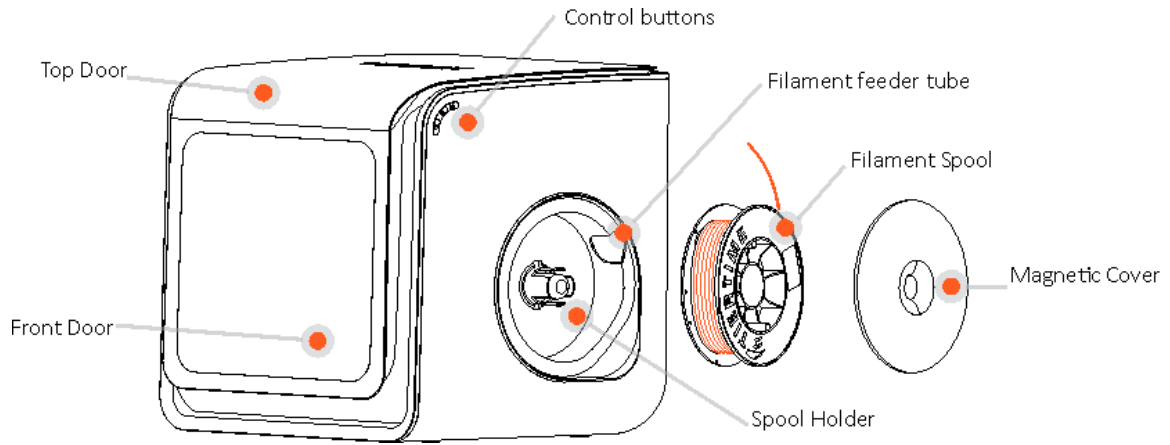

Unpacking the Afinia H800+ 3D Printer

The Afinia H800+ 3D Printer weighs over 40 pounds and should be team-lifted!



Remove the power cord and 4 perf boards from the top foam piece.

Remove top foam from the box. Lift the foam ring from around the printer.

With two people, carefully lift the Printer from the box.

Lift the foam sheet below the printer and remove the Accessory Pack, Power Supply, Putty Knife, and Snipping Pliers.

Lift the top cover and carefully lift out the foam above the platform.



Open the front door and carefully remove the two pieces of foam from under the platform. Tip each foam piece back until it is lying flat, then turn the foam counter-clockwise until the left end of the foam is through the door.

Use the snipping pliers to carefully cut the 6 labeled retaining strap loops from around the Print Head rails near the top of the printer.

Cut only the straps!

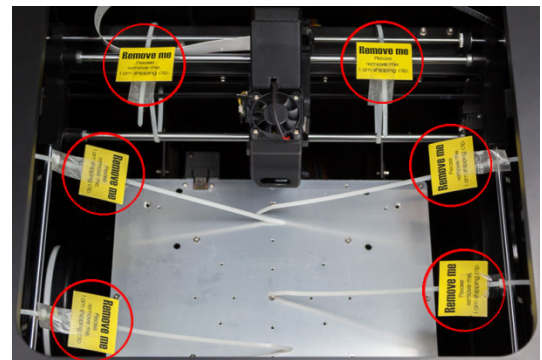

Next, check the Accessories:

- Reel of Filament (1, Natural/White)
- Power Supply
- USB Cable
- Extra Nozzle
- Nozzle Wrench
- Hex Wrenches
- Putty Knife
- Snipping Pliers

On top foam:

- Power Cable
- 1 Flex Board
- 2 Perf Boards



The Print Head

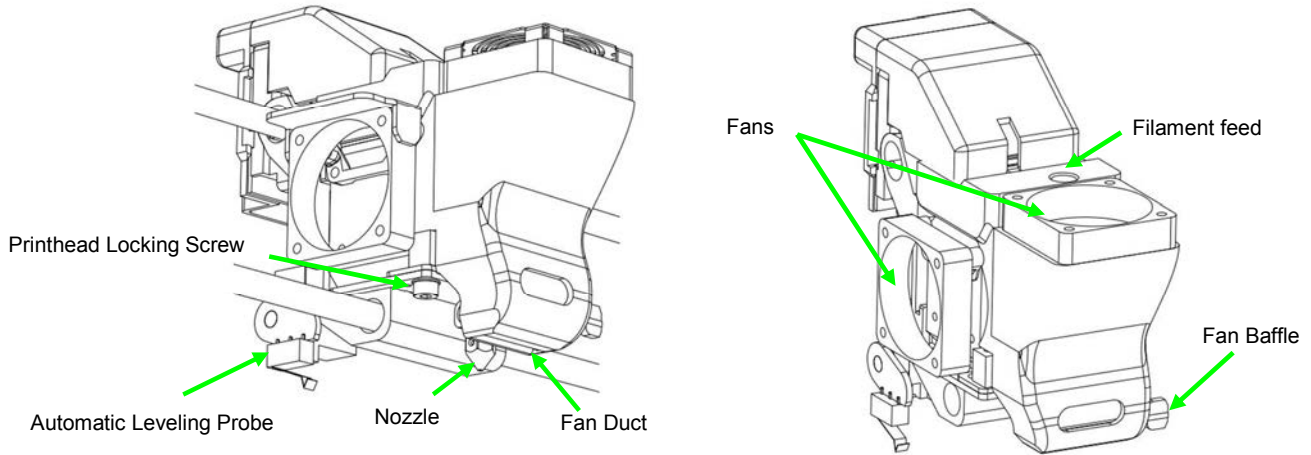

The Print Head is already installed in the Printer. You do not need to do any assembly.

The Control Buttons

You can do a lot with your Afinia H800+ by using the Control Buttons, so it follows your every command.

You also use the Afinia software to control the Afinia H800+.

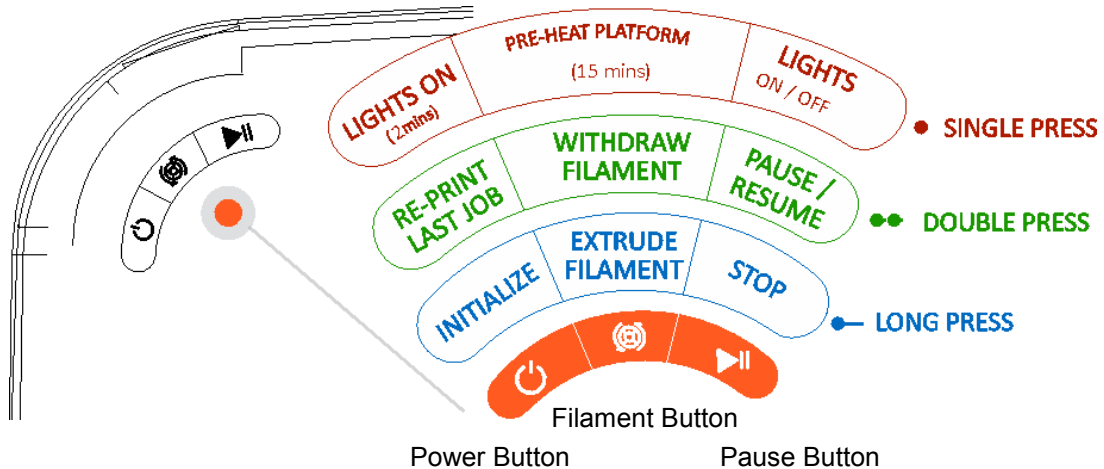

Installing the Afinia H800+ 3D Printer

You will need the USB Cable, Power Supply and Cable, and Filament Spool to complete the Afinia H800+ 3D Printer installation.

Driver and Software Installation

For PC installation, go to the Support Section of www.afinia3d.com to download the latest version of the Studio installer.

Double-click the setup.exe file to install the software. (The default installation path is C:\Program Files\Studio\). A pop-up window will appear. Select "Install" and follow the instructions to finish. The printer drivers will be installed along with the software.

The Mac version of the Studio installer can only be obtained through Apple App Store.

Installing the Printer

Connect the power adapter as shown with the flat side out and turn on the power switch.



Long Press the Power button on the control panel to initialize the printer.

Connect the printer to your computer using the supplied USB cable.

USB connection



The Printer will be recognized and automatically installed when it is connected to your PC or Mac.



You can also initialize the printer from the Studio software.

Loading the Filament Spool

- A. Insert the end of filament into the Filament sensor, which is on the upper right side of the spool holder.

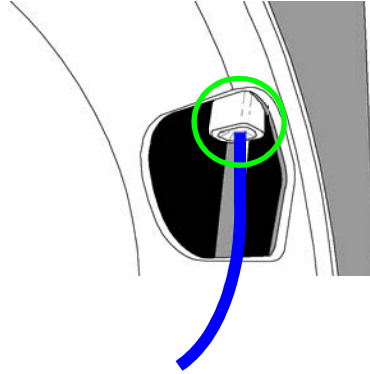

- B. Feed the filament through the tube until about 4 inches of filament protrudes from the tube.

- C. Put the Filament Spool onto the holder with the end of the filament pointing up from the back.
- For the 1KG spool, be sure to add the 1KG Spool holder add-on!

- D. Feed the filament into the extruder head as far as it can go (about 2 inches) using the feed tube just behind the fan.

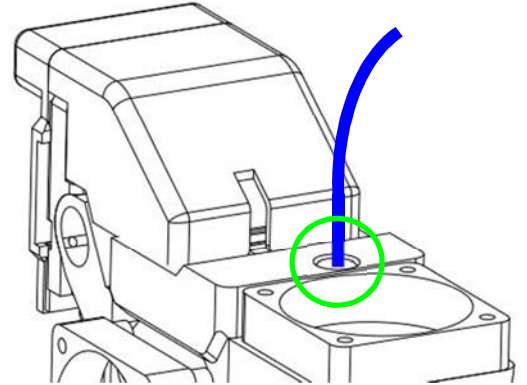

- E. Long Press the Filament button.
- If the filament doesn't start feeding when the printer beeps, gently push in the filament.
 - A thin stream of filament should extrude from the nozzle before the printer beeps again.

- F. Replace the magnetic filament cover.
- If you loaded a 1KG spool, be sure to use the 1KG spool cover!



Preparing the Platform

The print platform needs to be prepared so the model adheres to the platform enough to be printed while still being easy to remove from the platform when done.

Never print directly to the aluminum platform!

There are several options:

Perf Board (Glass-reinforced Epoxy Laminate)

The Perf board is held in place by the 13 mounting screws and two spring-loaded bearings.

Apply slight downward pressure on the two spring bearings when sliding the perf board back into place. The heads of all 13 mounting screws will lock down the board when installed correctly.

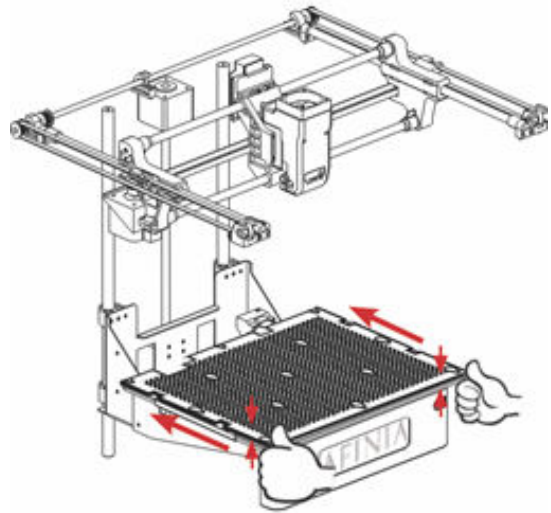
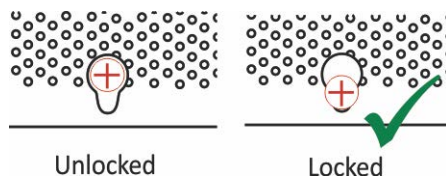

Flex Board (Perf board with pre-installed Flex surface)

The Flex Board is mounted in the same way as the plain Perf board.

Borofloat Glass

Many people use Borofloat glass as the print surface, brushed with an ABS/acetone slurry and allowed to dry into a thin ABS film.

The ABS film will hold the model to the glass, and release from the glass as the glass cools.

If the model does not easily release, spray a small amount of ammonia-based glass cleaner around the model. The same glass cleaner can be used to clean the film from the glass.

It is recommended that you clean and recoat the print surface after each print.

The Borofloat glass can be placed directly on top of the installed perf board or on the platform screws. Use office clips to hold the glass in place.

BuildTak Print Surface

BuildTak is a print surface that self-adheres to the plain Perf board or to glass. If adhering to glass, be sure that no air is trapped between the glass and the BuildTak.

Position the BuildTak surface on the actual print zone – the Perf board is larger than the surface, with the perimeter outside of the print zone.

Borofloat glass and BuildTak are available at store.afinia.com.

Whichever platform preparation method you use, having a well-leveled platform, a correctly-set nozzle height, and a pre-heated print surface will improve your results.

The next few pages walk you through these steps.

Software and Printer Settings

Starting the Studio Program

Open the Studio software on the desktop (Windows) or in the Applications folder (Mac).

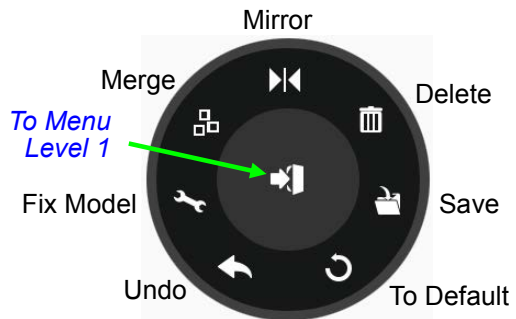
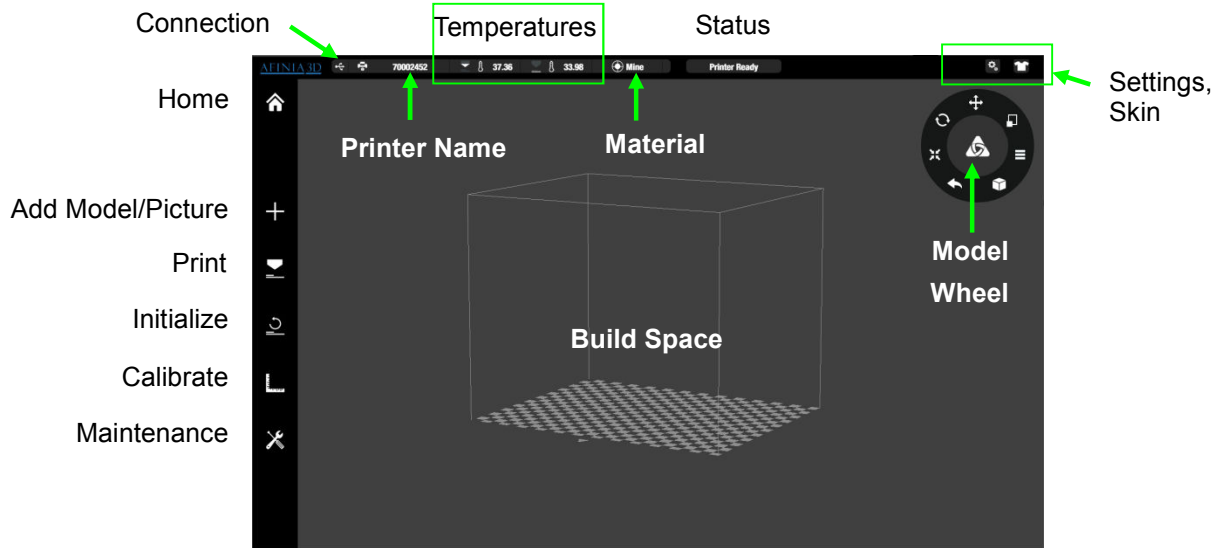

Changing the Language

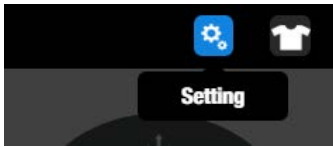

To change the language, click **Settings**.

Select the Language section and pick the language from the list.



Selecting the Printer

In the Settings window, select the Printer section. Click the printer you want to connect to. A red check will appear when you are connected.

You can only connect to one printer at a time.

Click the **Printer Detail** button.

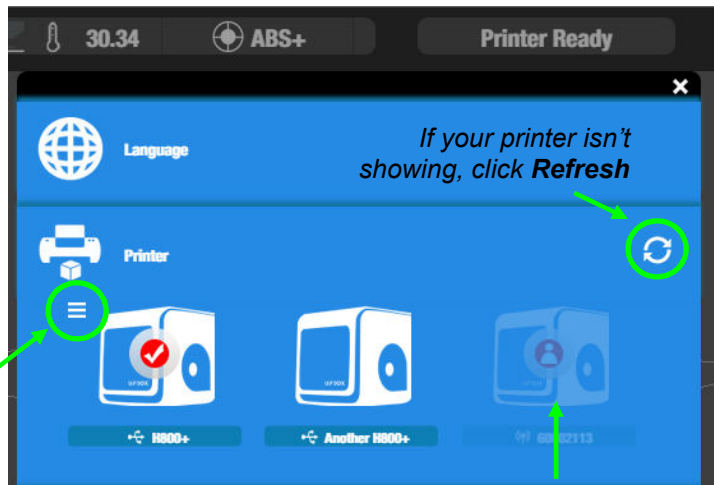

Enter the printer **Name**.

Someone is already connected to this printer via Wi-Fi

Wi-Fi Setup

If you will be setting up the Wi-Fi connection on the H800+ printer, follow the steps below.

In the Printer Detail, click the **Network** dropdown menu and choose your network name from the list of available networks.

Input the **Password** for the Wi-Fi network and click **Confirm**.



The printer **Name**, **Network**, 3D Printer **Type**, **IP Address**, **Serial Number**, and ROM **Version** will be displayed.

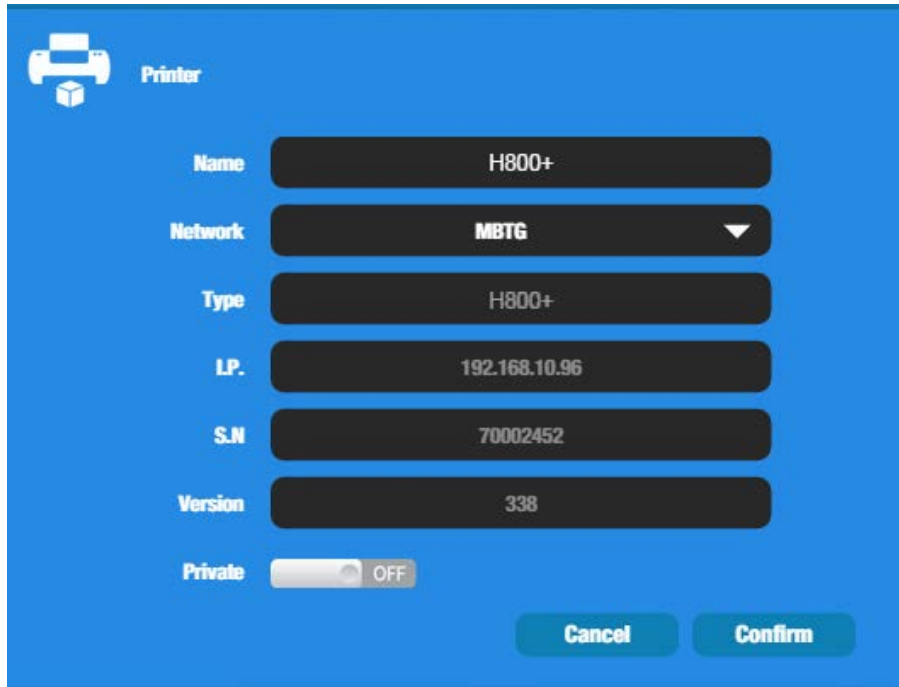

To limit the printer access via Wi-Fi to trusted users, turn **Private** ON and enter a password. Anyone connecting to the printer will need to enter this password to access the printer.



Please note that the password for private access is a weak protection that can be disabled or changed by anyone who connects to the printer through USB.

Click the **Confirm** button to save your changes.

Disconnect the USB cable and click the printer icon. The printer will now show with a Wi-Fi symbol rather than the USB symbol.
Click the printer to select it.



Version Management

Check your software version and use the link to check for new versions of the Afinia Studio software.

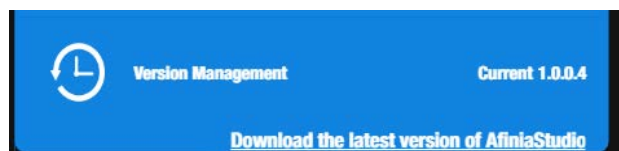

Getting Ready to Print

The Calibration Window

Click the **Calibrate** button to open the Calibration window.

Leveling the Print Platform

Before calibrating the nozzle height, check the vertical nozzle distance at each of the nine calibration points on the print platform.

If the nine calibration values are not all **0.00**, click the **Reset** button.

Click the **5** button to move the print head to the center of the platform.

Put the supplied Calibration Card between the nozzle and platform.

Use the height field and **Move** button to lift the platform until it is almost touching the nozzle (e.g. nozzle height).

Try to move the Calibration Card and feel the drag between the platform and the nozzle.

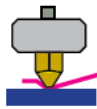
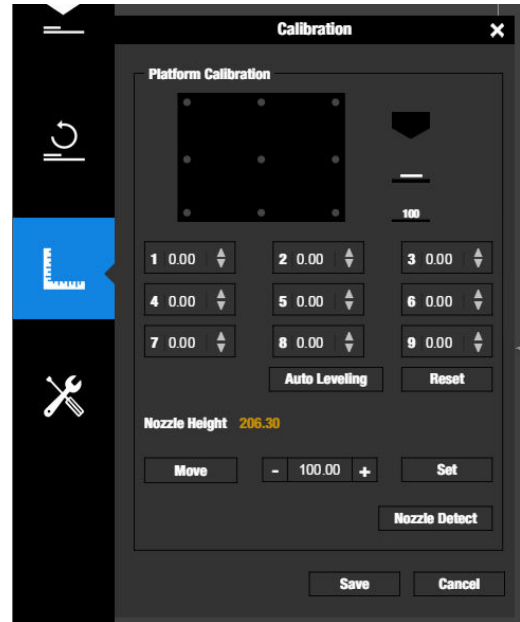

The platform is too high; the nozzle is pinning the Card onto the platform. Lower

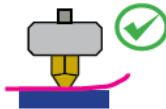

The height is just right; can feel some resistance but the Card moves freely.

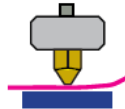

The platform is too low; no resistance is felt when moving the Card. Raise the platform slightly.

Use the nine position buttons to check that at each position the platform is close to the same distance from the nozzle.

If the platform is not close to the same distance from the nozzle at all nine points, adjust the platform until it is as level as possible. Use the 4 Leveling Dials under the platform arm to level the print platform.

Turning a dial clockwise will raise the platform above that dial.

Always recalibrate the platform and nozzle height after leveling the platform.



Leveling Dials
(Viewed from under platform)

The more level your platform is, the better your print will be!

Platform Calibration

Automatic Platform Calibration

Along with manual leveling the platform, the Afinia software can run a Platform Calibration to adjust the printing of the raft, laying down a level foundation for your model to be printed on and set the nozzle height.

Note: The Platform Calibration values will only affect printing when using a raft. If you are printing without a raft, the Calibration is not used.

With your print surface in place, click the **Auto Leveling** button and select the appropriate print surface.

The calibration process will check nine points on the platform then set the nozzle height.

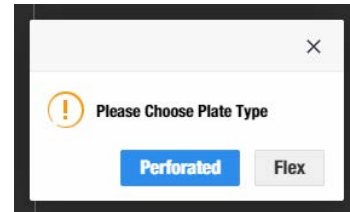

NOTE: If any of the values are left empty, the platform is too far out-of-level for the calibration to compensate. You will need to manually level the platform before running the Platform Calibration again (see page 14).

Manual Platform Calibration

The platform calibration can also be done manually on the H800+.

1. Click the button labeled **5** to move the nozzle to the center of the platform.
2. Use the **Move** button to raise the platform.
3. If clips are used to secure the print surface to the platform, position the clips so they do not interfere with the nozzle or wind barrier.
4. Raise the platform until the print surface is just touching the nozzle and note the current height.
5. Lower the platform slightly and check the other 8 calibration points.
6. Once you have found the calibration point with the lowest nozzle height, move to that point and adjust the platform position so the nozzle is just touching the print surface.
7. Click the **Set** button to set the nozzle height.
8. Once the nozzle height is set, select the distances from the drop-down lists that brings the platform at the other 8 points into contact with the nozzle.
9. Once all 9 values have been entered, click **Save**.
10. **Reset** will clear all calibration values.



Nozzle Height Calibration

Automatic Nozzle Height Calibration

The Automatic Nozzle Height Calibration process will only work with the supplied Perf boards, a Perf board with BuildTak adhered to the board or Flex boards as the print surface. **If you are using any other surface, manually set the nozzle height.**

Click **Nozzle Detect**.

Select whether you are using the Flex board (or plain perf board with BuildTak) or a plain Perf board.

The extruder will move above the Nozzle Sensor and platform will lift until contact is made. The nozzle height will be changed.

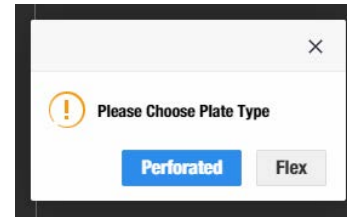

Manual Nozzle Height Calibration

To manually set the correct nozzle height:

1. Click the numbered calibration button with a calibration value of **0.00**.
2. Raise the platform by entering a value into the number box and click **Move**.
3. Check the distance between the nozzle and the print surface. If the platform is more than 0.2mm from the nozzle, slowly raise the height value and click the **Move** button. Small changes will help avoid striking the print surface into the nozzle.
4. Repeat until the print surface is 0.2mm from the nozzle. Use the supplied Calibration Card to find the correct distance.

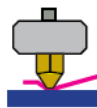

The platform is too high; the nozzle is pinning the Card onto the platform. Lower

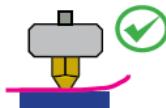

The height is just right; can feel some resistance but the Card moves freely.

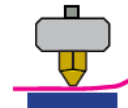

The platform is too low; no resistance is felt when moving the Card. Raise the platform slightly.

5. With the print surface 0.2mm from the nozzle, click the **Set Nozzle Height** button to save the current nozzle height.

If you have manually leveled the platform since the last time the Auto Level was run, re-run the Auto Level, entering the height value you just found after the process is complete.

TIP: If the print surface contacts the nozzle while making height adjustments, re-initialize the printer and before undertaking any other operations.

The Maintenance Window

Click the **Maintenance** button to open the Maintenance window. This window is used to change filaments and filament types.

Extrude heats the nozzle and loads material into the nozzle. When the temperature is high enough the material is squeezed out of the nozzle. The printer beeps before material starts extruding and it beeps again when finished.

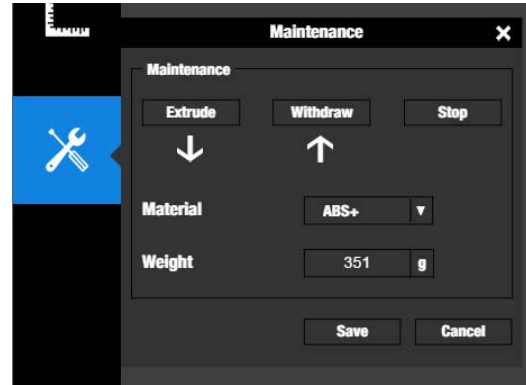

Withdraw clears the filament from the nozzle when you change the filament or if the nozzle needs to be cleaned. When the nozzle is up to temperature and the printer beeps, gently pull out the material.

Stop will halt the extrusion or withdraw process.

Click **Material** to change the type of filament being used and enter the **Weight** in grams.

TIP: An empty Afinia Premium spool weighs about 280 grams. If you are installing a partially used Afinia Premium filament spool, weigh it, and subtract 280 grams from the weight. Enter that value into the material Weight text box.

Adding Customized Material

To add up to 4 custom filament types, select **Customize** from the Material selection list.

Click **Add**. Enter the Name, Nozzle, and Platform temperatures, then click **Save**. The custom material entry can now be selected.



Be sure that the nozzle temperature entered does not exceed the temperatures allowed by the filament type!

Loading a 3D Model

1. Single-press the Filament button to start the 15 minute platform preheat.
2. Click the **Import Model or Image** button and click **Model**.

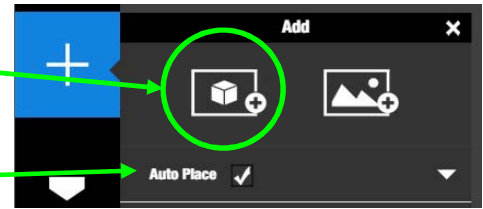

*Leave the **Auto Place** option checked to center the model in the build space and at the right height.*

3. Choose your model.

*The Studio software only supports **STL** files and **UP3** formats.*

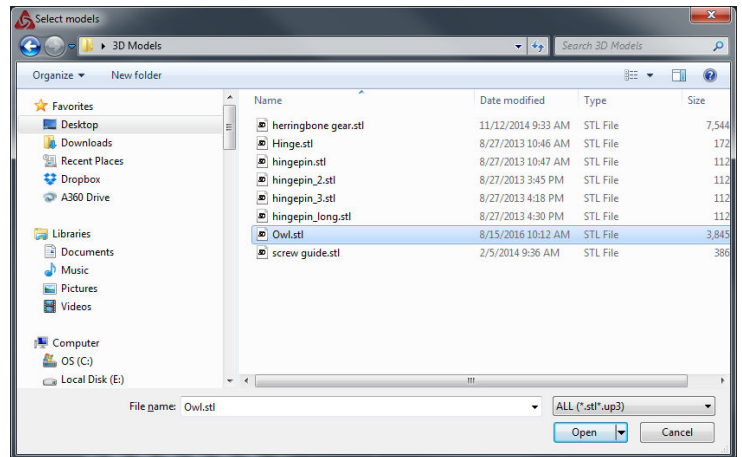

4. The selected model will be loaded into the Build Space.

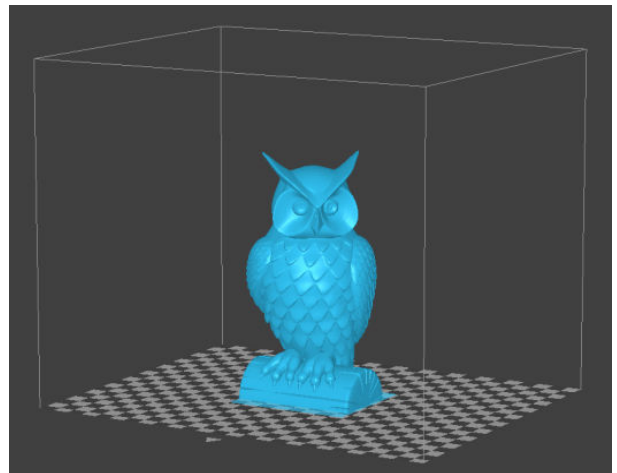

Basic Printing

Basic printing is nothing more than selecting a few of the more common settings and printing the model as it was loaded into the software.

Printing a 3D Model

1. With the printer connected, click the **Print** button.

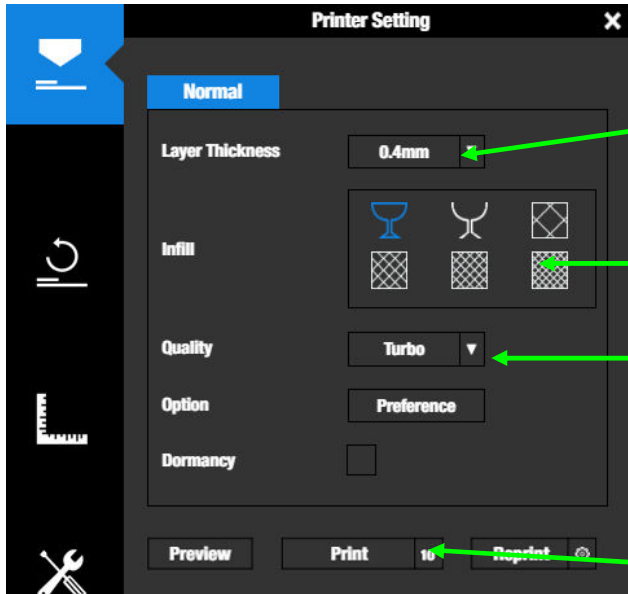

2. Set **Layer Thickness**.
3. Set **Infill Type** (see below).
4. Set **Print Quality/Speed**.
5. Check **Dormancy**: “sleep” when done.
6. Click **Print**.

7. The time and material needed will be displayed once slicing and sending is complete.

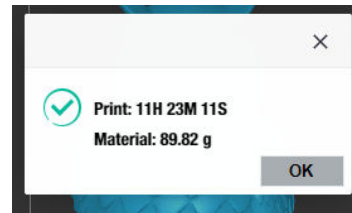

8. Printing will start automatically once the nozzle has heated.

You can now safely disconnect the printer from the computer!

Infill Types

There are 6 infill types.

Surface: No top or bottom, no infill, single perimeter

Shell: No infill, normal wall

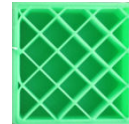

Big Hole (12% infill)

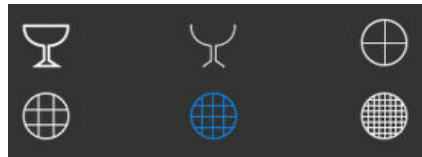

Hollow (17% infill)

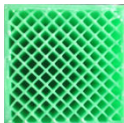
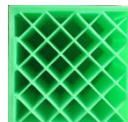

Loose (25% infill)

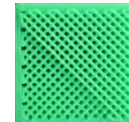

Solid (50% infill)

Print Progress

The progress of your print will be displayed in the LED bar below the print platform.



Pausing or Stopping a Print

A print in progress can be paused or stopped either in the Studio software or using the controls on the H800+.

In Studio:



Click **Stop** to cancel the print

Click **Pause**

Once paused:



Click **Resume** to start printing again

Click **Maintenance** to change filament

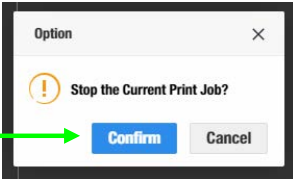

Click **Stop** to cancel the print

Using the Control Panel:

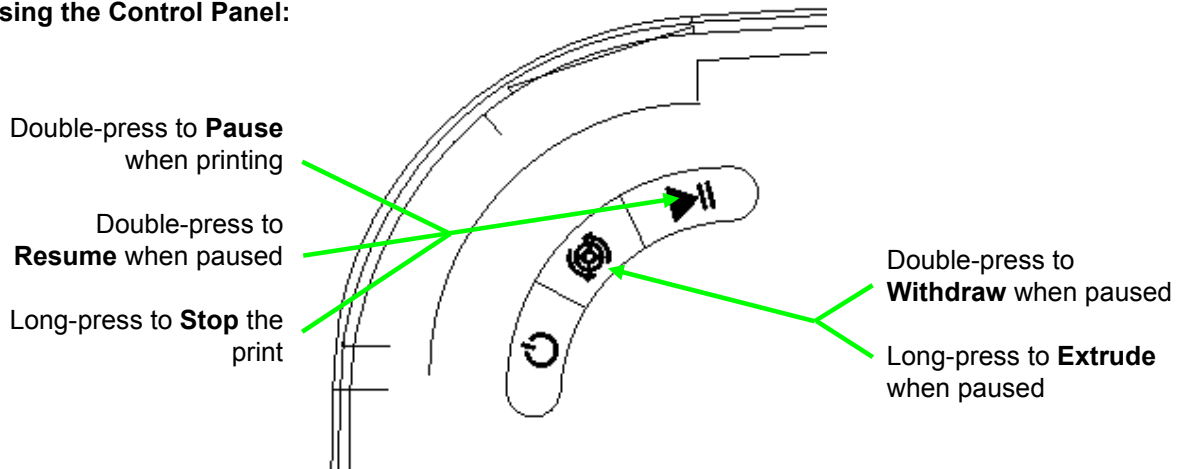

Advanced Printing

Advanced printing uses the processes described in Basic printing, but adds more functionality by loading more than one model into the build space, using the Right-click menu, the Model Wheel, and changing advanced print settings.

Loading Multiple Models

You can load multiple models to the build space.

Click to select a single model.

Ctrl-Click to select more than one model.

To de-select all but one model, **click** the one model to remain selected.

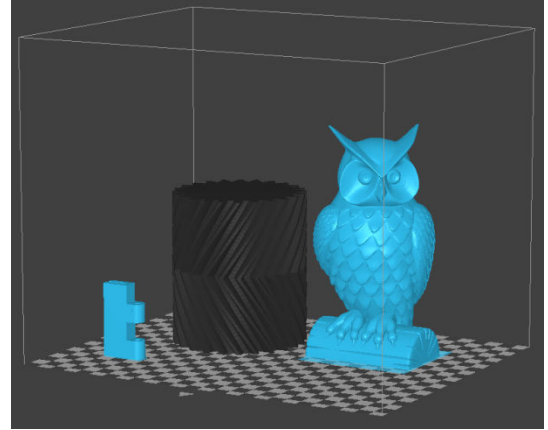

Any of the following actions, aside from **Auto Place**, will be applied to all models that are selected. Auto Place always applies to all loaded models.

Right-click Menu

With a model loaded, right-click the Build Space to display a menu of additional features.

Click **Copy** to select the number of additional copies to add to the build space.

Delete will remove the selected or models from the build space.

Select All will select every model on the build space.

Unselect All will de-select every model on the build space.

Initialize view returns the view to the default “free” view.

Rotate around the Center of Models does something, I guess.

Exit will close the Studio software.

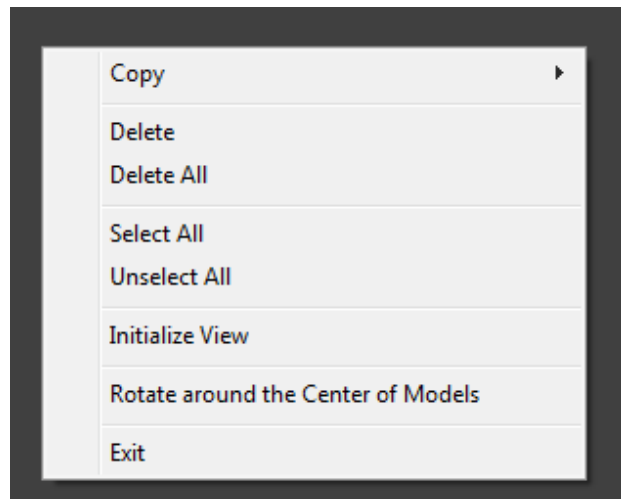

Model Wheel, Menu Level 1

The first level of the Model Wheel allows you to change the orientation, position, and size of the model or models selected.



Rotation

The **Rotate** control allows you to change the orientation of the model by selecting an axis and the degree of rotation.

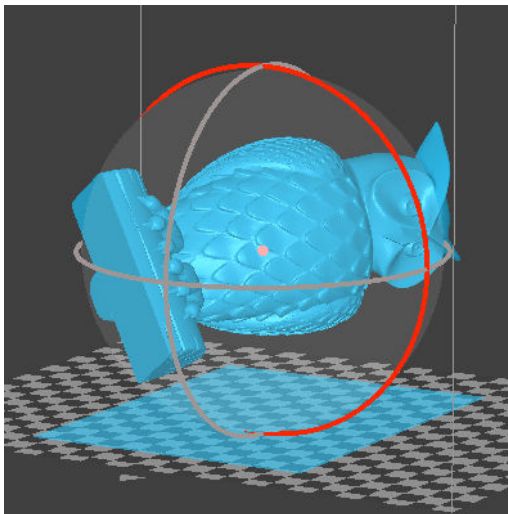
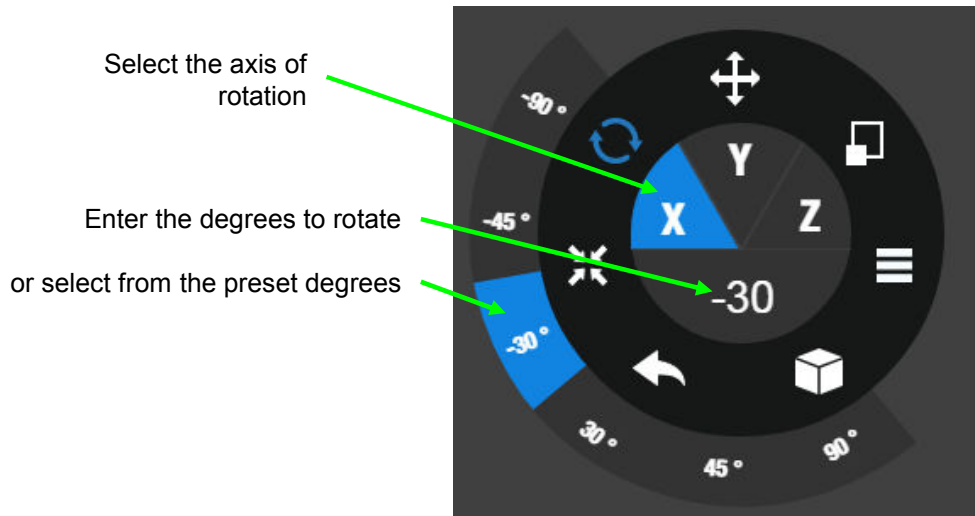

Alternately, click axis and rotate the model using the mouse click-and-drag

The degrees of rotation will be displayed until the mouse button is released

Movement

The **Movement** control allows you to change the orientation of the model by selecting an axis and the degree of rotation.

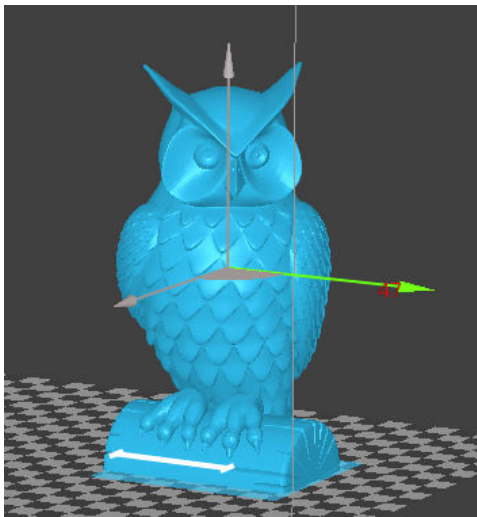
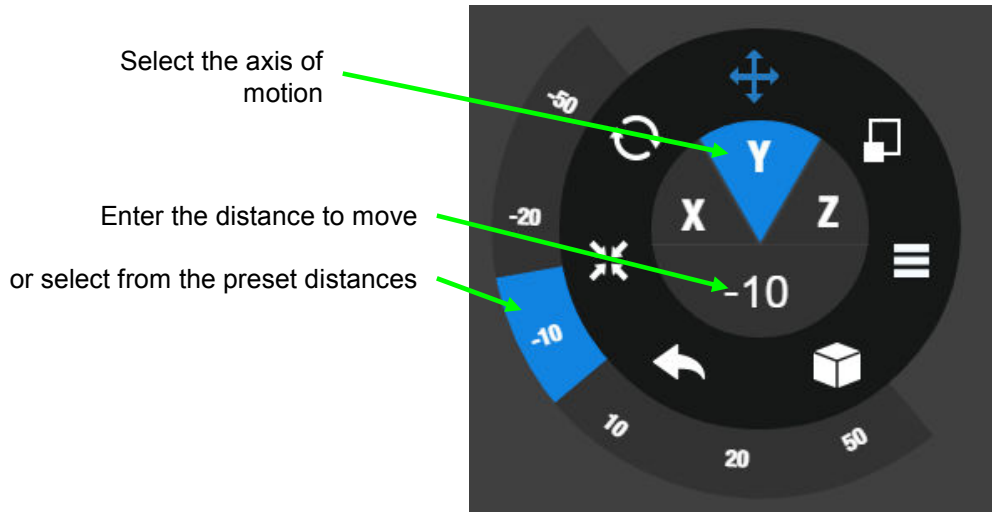

Alternately, click an axis and move the model using the mouse click-and-drag

The distance moved will be displayed until the mouse button is released

Click the quarter-circle between the X- and Y- axis arrows to free drag in both directions at once

The distance moved will be displayed until the mouse button is released

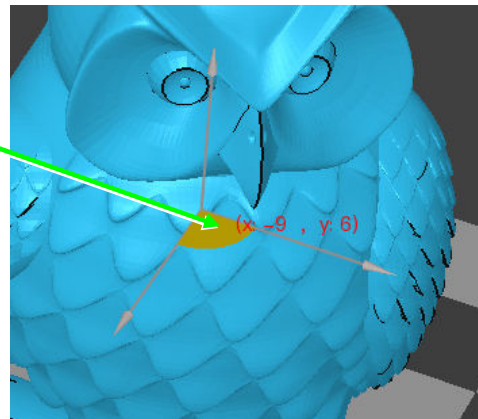

Scaling

The **Scale** control allows you to change the size of the model.

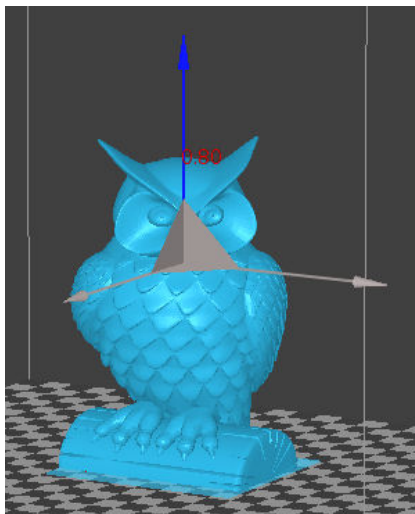
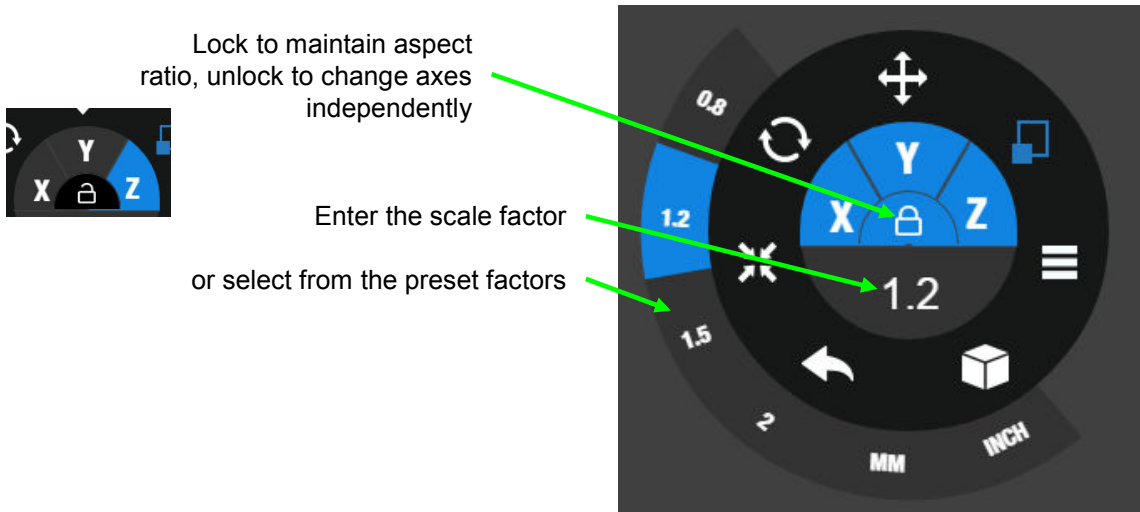

Alternately, click an axis and scale the model using the mouse click-and-drag

The scale factor will be displayed until the mouse button is released

If the aspect ratio is locked, the triangles connecting the axes will be orange and click-and-drag will apply to all three axes

Auto Placement

Click the **Auto Place** button to automatically arrange any models in the build space. Aside from spacing between the models, they will also be placed in contact with the bottom of the space.

Undo

Click the **Undo** button to revert any changes in the reverse order in which they were made since the last Print or Preview was done.

Views

Click the **Views** button to change how you are looking at the model. Select from 7 preset views using the wheel.

Click the center button to return to Level 1 of the Model Wheel.

You can also change the view using the mouse at any time.

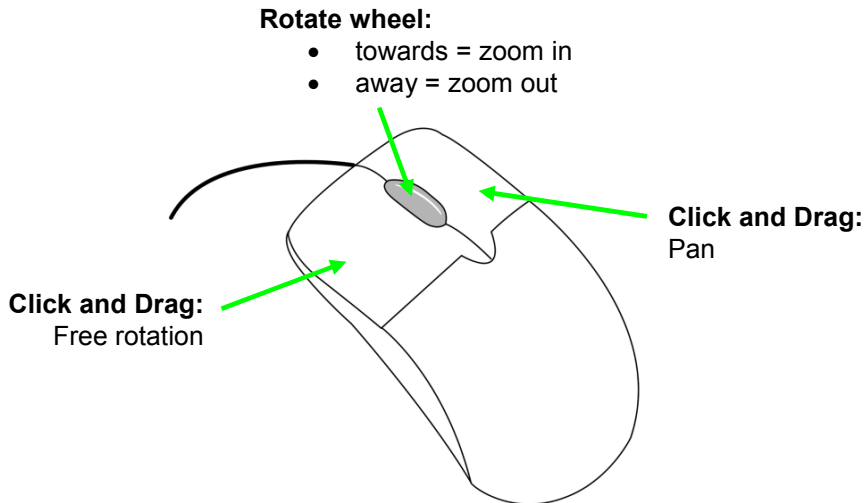

Model Wheel, Menu Level 2

The second level of the Model Wheel allows you to fix, merge, mirror, delete, and save models.

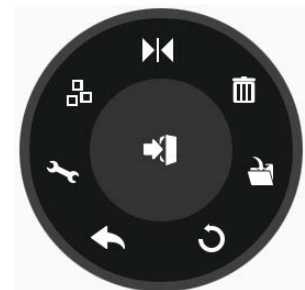

Fix

If the model appears with red surfaces, the model isn't solid and may give you unusual print results. Click the **Fix** button to try to repair the model.

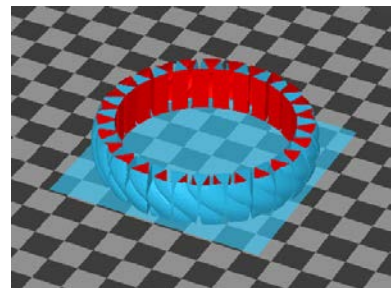

Merge

If you have more than one model in the build space, you have the option of merging the files.

Files that have been merged will be considered a single object, eliminating the possibility of overlapping rafts during printing.

In the example to the right, the two hinges have been selected but have not yet been merged. The lower screenshot is after the merge; the two parts are joined as indicated by the light blue line connecting them (the line will not print).

Merged files can also be saved into one .UP3 file.

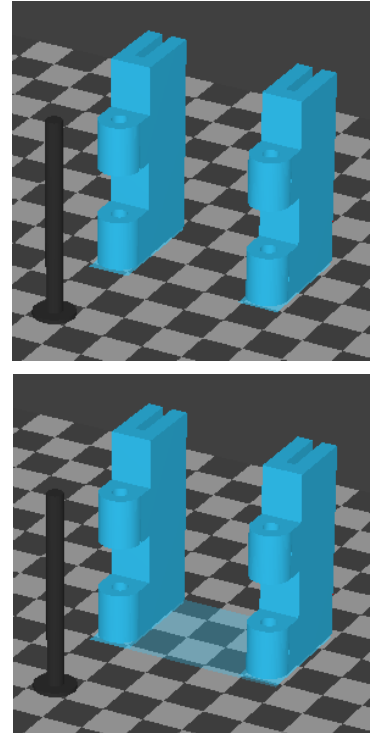

Mirror

The **Mirror** function will flip the model horizontally, using the X-axis as the mirror.

Delete

Use the **Delete** button to remove the selected models from the build space.

This is similar to using the **Delete** option in the Right-click menu or pressing the delete button on the keyboard.

Save

Click **Save** to save the selected model(s) to the .UP3 format.

If you have more than one model selected, the models will be merged during the save.

Reset to Default

Click the **Reset to Default** button to revert all changes made since the last Print or Preview.

Undo

Click the **Undo** button to revert any changes in the reverse order in which they were made since the last Print or Preview was done, same as the Undo in the first menu level.

Return to Main Menu

Click the center button in the wheel to return to the first menu level.

Advanced Print Settings

Advanced print settings can be selected by clicking the **Preferences** button in the Print window.

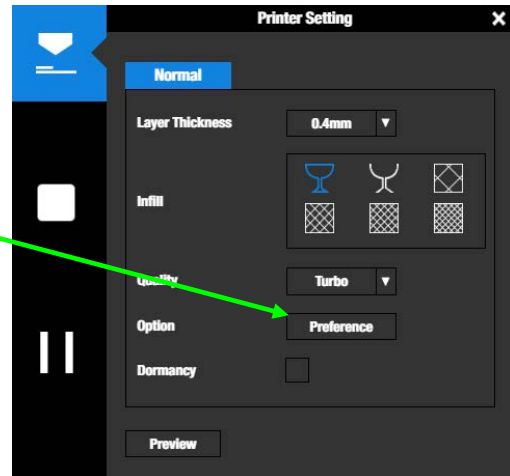

Part Settings

Surface

Select how many layers horizontal surfaces printed at the top and bottom of the object.

Angle

Select the angle of the print path in each layer, compared to the platform.

Support Settings

Dense

Select the number of dense support material layers printed directly beneath the model. More layers of dense support makes for a more stable print but takes longer to print.

Angle

Select the maximum Angle from horizontal at which support material will be printed. The printer will add solid support layers under the part if the angle is below this setting.

Area

Select the minimum Area of a surface for which support material will be printed. Areas smaller than this setting will not have support material printed.

Space

Select the distance between the lines of support material. Changing this value will change how the support material is printed; removal of support material and print quality can be affected.

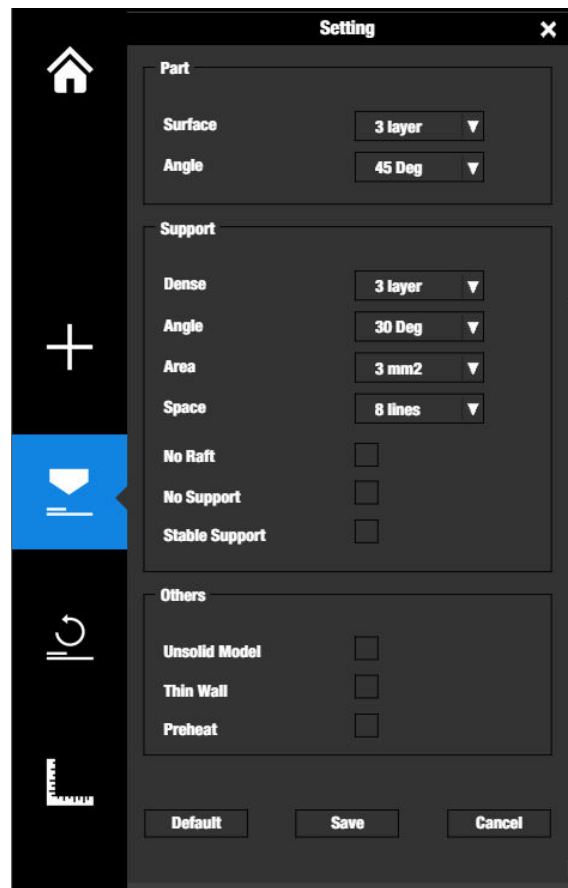

No Raft

Checking this box will cause the model to print without a raft.

NOTE: With no raft, the platform calibration is ignored and any inconsistencies in how level the platform is will affect the final print result!

No Support

Support material will not be printed if checked. This may affect print results on models with overhanging areas.

Stable Support

If checked, the support structures will be stronger but harder to remove.

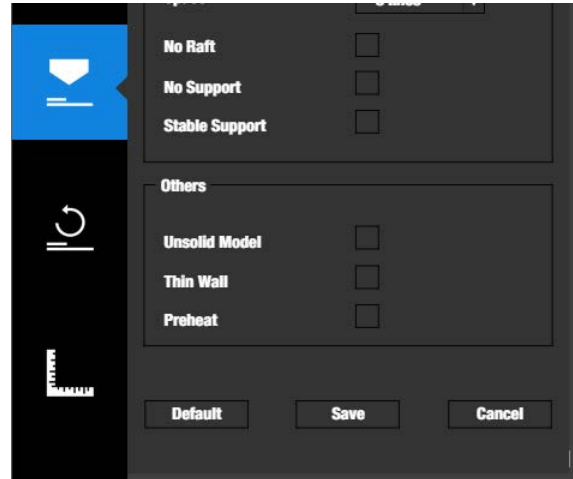

Other Settings

Unsolid Model

The software will attempt to fix non-solid models during printing if checked.

Print results will vary for unsolid models.

Thin Wall

If checked, the software will detect wall thicknesses that are too thin to print and expand the wall to printable size.

Preheat

If checked, the print platform will preheat for 15 minutes before printing starts.

Status Indicator

The table below explains what each Status Indicator state means.

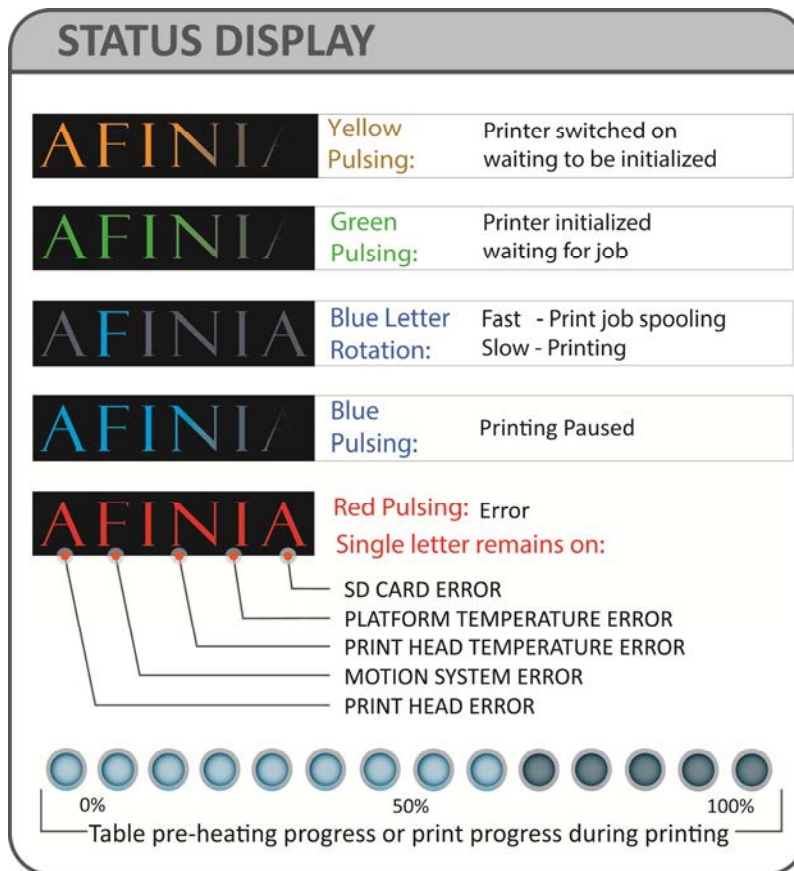

Filament Check

The H800+ includes a filament sensor that will pause the print if the filament has run out, allowing you to change the spool without having to start the print over again.

If the filament sensor detects the filament has run out, the print will be automatically paused.

Withdraw any remaining filament and load a new spool.

Extrude from the new spool until the filament is flowing.

Resume the printing using either the **Resume** button in the software or by double-pressing the **Pause** button on the control panel.

Power Failure Recovery

If power fails during a print, the next time the printer is initialized and the software connects to the printer, the user will be given the choice of continuing the print or cancelling the print. Click **OK** to continue or **Cancel** to discard the print.

Converting a 2D Picture into a 3D Model

You can convert a 2D picture into a 3D printable model using the Studio software.

Click the **Add Picture** button and browse for the image

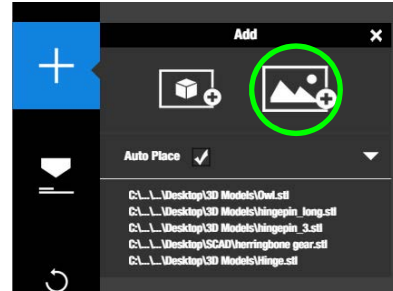

Back to Printing when you're done

Zoom, Move, and Center Controls

Preview

Set the **Base** and **Model Heights**

Click **Toggle Color** to switch between engraved and embossed

Click **Style** to change from Gray (gradient) to Sculpture (one height)

Change the **Size** of the model

Pen, Erase, Text, and Crop tools to modify your image – set tool size, style, font, etc.

Previous to clear current changes, **Apply** to accept current changes

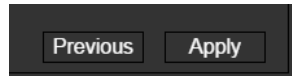

Select from the Change History to go back to any previous step

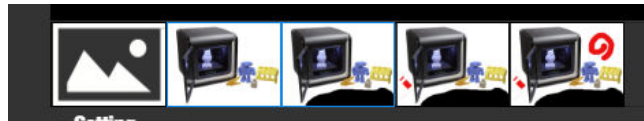

Click **Back** to add the 3D image to the build platform

Don't forget to save your model!

Model Removal

Never attempt to remove the finished model from the print surface while it is still in the printer!

This can affect the platform leveling or bend the entire platform assembly so that it is no longer perpendicular to the printer head.

Use gloves when removing the print surface and model from the printer, as the print surface and model may still be hot. The gloves will also protect your hands from any tools being used to release the model from the print surface.

If you are using the Perf board, press the front corners slightly and pull the board forward to release it.

If you are using any method that clips another surface to the printer platform, simply remove the clips holding the surface to the platform and remove the entire print surface.

Removal from Perf Board

Gently slide the supplied putty knife under the model and slowly wiggle it back and forth to lift the support material from the print surface.

Be sure to clean any remaining material **from both sides** of the Perf Board once the printed model and raft have been removed.



Removal from Borofloat Glass

After removing the glass from the printer platform, allow the glass to cool completely. As the glass cools, you may hear cracking sounds – this is the ABS film releasing from the glass.

If the model doesn't release from the surface of the glass, spray a small amount of ammonia-based window cleaner onto the surface of the glass near the edge of the model. After a few moments, the model should release.

You might need to reapply the ABS film to the glass after each print.

TIP: Depending on the platform preparation method you are using, the model may be easier to remove from the printer when it is still hot. If you want to heat the platform before removing your model, use the **Table Heat** option from the **3D Print** menu.

	<p>CAUTION: It is strongly recommended that you do not attempt to remove the model from the platform while the platform is still attached to the printer. Doing so may damage the printer or affect the platform level and nozzle height calibration.</p>
	<p>GLOVES: It is recommended that gloves be worn as the platform may still be hot and to prevent injury from any tool being used to help remove the model from the platform.</p>

Maintenance

Changing the Filament

Changing the filament can be done either in the software or using the control panel.

1. Remove the magnetic Spool Cover.
2. Select **Maintenance** from the **Print** menu and click **Withdraw**.
-or-
 Double Press the **Filament** button.
3. Insert the end of filament into one end of the Filament tube, which is on the upper right side of the spool holder.
4. Feed the filament through the tube until about 4 inches of filament protrudes from the tube.
5. Put the Filament Spool onto the holder with the end of the filament pointing up from the back.
6. Feed the filament into the extruder head as far as it can go, about 2 inches.
7. Click **Extrude** in the **Maintenance** window
-or-
 Long Press the **Filament** button.
8. If the filament doesn't start feeding when the printer beeps, gently push in the filament.
9. Replace the magnetic filament cover.
10. If you are changing filament types, select the **Material** and enter the **Weight** of the new spool.
 This must be done in the **Maintenance** window, not from the control panel.

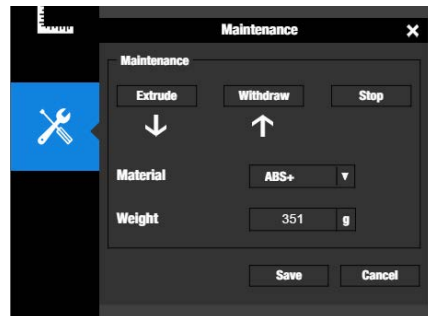

TIP: If you are loading a different color filament than the last spool, run **Extrude** a few times before you start printing. This will help remove any left-over filament of the previous color.

	<p>CAUTION: If the nozzle is blocked, remove the nozzle and clean it.</p>
	<p>GLOVES: The extruder and platform are hot. Use gloves when working in this area of printer.</p>

Cleaning the Nozzle

The outside of the nozzle can get covered with a layer of filament during regular use. When the printer is printing, this layer may melt on the nozzle and leave discolored spots in the model or even clog the nozzle. To avoid this, regularly clean the nozzle.

1. Click **Calibrate** and use the **Move** controls to lower the platform to the bottom.
2. **Withdraw** the filament to heat the extruder and melt the coating of filament.
3. Use a heat-resistant material such as 100 percent cotton cloth or soft paper and a pair of pliers. With the material between the pliers and the nozzle, apply gentle pressure and turn the pliers to remove the filament material. **Do not apply heavy pressure!**

Remember, the nozzle can heat up to 260° C (500° F) – that's over two and a half times the boiling point of water. **Do not touch the nozzle or nozzle mount with bare skin!**

If this does not clear up any issues, remove and soak the nozzle in acetone overnight to remove excess ABS material from the nozzle. Ultrasonic cleaning baths also work.

Removing / Changing the Nozzle

If the nozzle becomes blocked, you will need to remove the nozzle in order to unblock or replace it.

1. Lower the platform to the bottom.
2. Click the **Withdraw** button on the Printer or Maintenance dialog box to remove the filament from the nozzle.
3. Once the Withdraw has completed and before the heater has a chance to cool below 200° C, use the nozzle wrench provided in the toolkit to remove the nozzle.
4. Use the same process to replace the nozzle, being sure to heat the extruder to at least 200° C before tightening the nozzle back down.

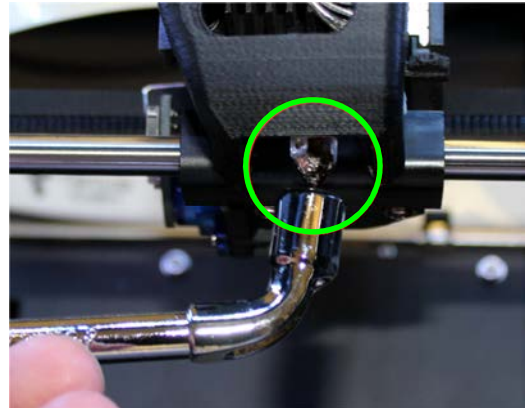

Do not apply too much torque to the nozzle to avoid twisting the heater assembly!

TIP: Heating the nozzle to 200° C will make it easier to remove and replace.



WARNING: Be careful when handling the heated nozzle and nozzle wrench!

Cleaning the Extruder Gear

The gear in the extruder may occasionally need cleaning to keep the filament feeding smoothly.

1. Withdraw the filament from the extruder head.
2. Long Press the **Initialize** button on the Control Panel to put the printer in sleep mode.
3. Turn off the power switch on the back of the printer.
4. Disconnect the Ribbon Cable from the Print Head.

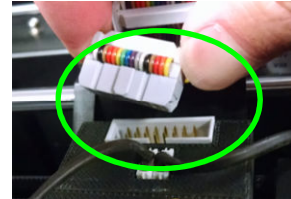

5. Remove the mounting screw underneath the print head.
6. Remove the Print Head from the Print Head mount.
7. Unplug both fans and remove the left fan.

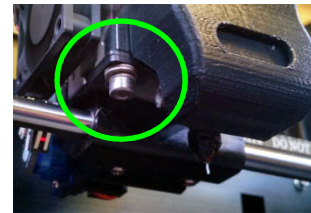

8. Slide the Print Head Cover off the Extruder Motor.

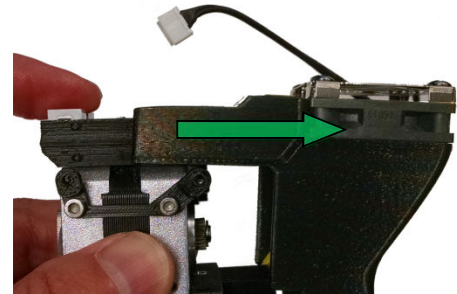

9. Remove the two screws on the Extruder Gear Cover and remove Cover.



10. Clean any filament debris from the teeth of the Extruder Gear.
11. Replace the Extruder Gear Cover and screws.
12. Replace the Print Head Cover. Slide it into place until the Cover clicks.
13. Remount the left fan and connect both fan plugs.
14. Replace the Print Head into the Print Head mount.
15. Replace the mounting screw underneath the print head
16. Reconnect the Ribbon Cable.
17. Turn on power and Long Press the **Initialize** button.

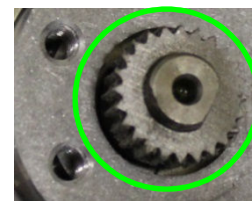

Cleaning the Platform

Regardless of your method of preparing the platform, a smooth surface will improve your results.

- If you are using the Perf Board as the print surface, you should remove any remaining filament material from both sides of the board before printing again.
- If you are using blue painter's, kapton, or other type of tape on the platform, replace the tape once it becomes uneven. Remove excess adhesive from the platform before replacing the tape.

Lubrication of Extruder Rails

The extruder rails on the Afinia H800+ 3D Printer requires lubrication every 4-6 months to keep it operating smoothly. Different lubricants are required for the two rail bearing types.

- The Front-to-Back rails should be lubricated with lithium grease such as Mobil XHP 220.
- For the Left-to-Right rails, use lubricating oil such as Mobil SHC 630.

When lubricating the bearings, clean the rails as much as possible before applying new lubricant. Slide the extruder several times in the all directions to spread the lubricant evenly.

If you have any questions about lubricating the rails, please contact Technical Support (see page 46 for contact information).

Changing the HEPA Filter

We recommend changing the HEPA filter after 300 hours of printing or 6 months, whichever comes first.

1. Rotate the filter cover **counter-clockwise** to remove.
2. Remove the old filter.
3. Install the new filter in the guide brackets.
4. Replace the filter cover and rotate **clockwise** to lock.

The HEPA filter should be replaced by a Class 7 or better filter.



Spare parts

Some of the plastic parts on the printer can be printed by the Afinia H800+ 3D Printer itself. If you need spare parts for your printer, the files for the printable parts can be found in the **C:\Program Files\Afinia\Example\Spare Parts\H800+** folder on PCs and in the **Afinia** directory off the root of the current User directory on Macs.

Tips & Tricks

Preheat the platform before printing

Large parts can sometimes have corners lift from the platform, which causes the part to distort.

Preheating the platform to at least 80% of the set platform temperature is a step you don't want to miss. Having the platform heated before print starts helps keep the model adhered to the platform during printing.

Monitor the platform temperature in the ribbon at the top of the software window.

Level Platform and Correct Nozzle Height

Two keys to successful printing and removal of the print raft is to make sure the platform is level and that the nozzle height is set correctly. Manually level the platform as much as possible, then run the **Platform Calibration** or **Auto Level** utilities to calibrate the platform and set the nozzle height.

Be sure to use the calibration utility to build a flat raft surface right below your model!

Position the parts as close to the center of the platform as possible

The edges of the platform are more susceptible to cooling than the rest of the platform. Try to avoid printing any object near the edges of the platform.

Model Orientation Tips

Generally, follow these three simple tips on model orientation for better print results:

- a) Position the model so the largest flat surface is on the bottom
- b) If your model has any cylindrical parts (either solid or holes), position them so they are vertical
- c) Minimize support material by orienting the model with as many concave surfaces up as possible

Remember, these orientation tips may not apply to all models. Each model is unique and has its own best orientation for printing.

Minimum Model Cross-Section

Due to the width of the extruded filament, models with portions that have a horizontal cross-section of smaller than **0.8mm to 1.0mm** may have missing print areas. Use the **Thin Wall** setting to compensate if necessary.

Merging and Rafts

Positioning multiple models too closely in the software can result in overlapping rafts, leading to print failure. Use **Merge** in the **Edit** menu before printing to have the software eliminate that problem by creating a single raft instead of several.

Be sure to save these merged models if you will be regularly printing them as a group!

Minimal Support Material Use

The Afinia 3D Software includes a feature that allows you to avoid most support material. When specifying the Print Preferences, select **0 mm²** for the **Support Area** or check **No Support**.

Support material around the bottom of the model will still be generated, but the amount of support material will be greatly reduced.

Tighten the Platform Screws

Over time, the screws holding the perf board to the platform may loosen. Tighten them occasionally with the perf board installed, but leave them loose enough to remove the board.

Shell Setting Tips

The **Shell** option for the print **Fill** setting can be used to create truly hollow prints, saving time and filament. However, not all models can be printed with this fill setting.

Models with relatively small horizontal or near-horizontal surfaces are potential candidates for shell printing, as these surfaces require little or no internal support to be successfully printed. Remember, each model is different – you may need to experiment with each model to find out if it can be used with **Shell** printing.

Decrease print time where possible

The faster you can print parts, the less lifting from the platform you are likely to get. Some ways to increase print quality include:

- If possible, try to avoid printing large parts in solid mode
- Set the layer resolution to as large a value as possible while still keeping the quality needed for the finished part
- Print the part in **Normal**, **Fast**, or **Turbo** mode
- If printing multiple parts at once, reduce the number of parts that are being printed

Changing Filament while printing

If you need to change the filament during printing, Double Press the **Play** button on the control panel.

When paused, Double Press the **Filament** button to remove the current filament. After changing filaments, insert the new filament and Long Press the **Filament** button to load your new filament.

If you are changing colors, you may need to extrude a few times to remove the last of the previous filament color.

Keep the extruded filament string connected to the nozzle – pull it from the nozzle just before the nozzle contacts the print surface after resuming the print by Double Pressing the **Play** button again; this helps keep stray strands from sticking to your model.

Model Creation: What does “Manifold” mean?

For any model to print correctly, it should be a manifold object. What this means is, as simply as possible, is that each edge must be in contact with two and only two surfaces. Most design software will allow you to create non-manifold objects, which can result in print problems.

The most common way for a model to become non-manifold is when several objects are joined together, creating surfaces in the model that are in contact with or crossing through each other.

Fix in the **Edit** menu of the Afinia 3D software may repair the non-manifold problem areas, but the best solution is to correct problems in your design software. Many software packages can check for and repair non-manifold models – consult the documentation for your software.

Model Creation: What does “Surface Normalization” mean?

The outer layer of every 3D printed object is actually composed of an outer surface and an inner surface. Surface Normalization means these surfaces are pointing the correct way. If you have an outer surface buried inside your model, or have an inner surface on the outside of the model, you will need to normalize the surfaces.

The most common reason for non-normalized surfaces is when two surfaces cross each other.

Fix in the **Edit** menu of the Afinia 3D software may resolve the surface problems, but the best solution is to correct the problem in your design software. Many software packages can check for and remove non-normalized surfaces – consult the documentation for your software.

Troubleshooting

Problem or Error message	Solution
No power	Verify power cord is securely plugged in.
	Verify the power switch on the back of the printer is on.
Extruder or platform fails to reach operating temperature	Verify printer has initialized. If not, Long Press the Power button on the control panel to initialize the printer.
	Heater is damaged. Contact Technical Support (page 46)
Material not extruding	Material is stuck in the extruder; remove the material (see page 34)
	The nozzle is clogged and needs to be cleaned or changed (see page 35)
Cannot communicate with printer	Print Drivers are not installed. Run the full installation
	Printer not initialized; use Initialize button on the control panel or Initialize function in software
	Make sure the USB cable is connected to the printer and to the computer
	Unplug the USB cable, then plug in again
	Reset the printer—power off then power on
	Restart the computer
Others	Contact Technical Support (see page 46)

Specifications

Printer Physical Characteristics

Printing Material	ABS or PLA Plastic
Layer Thickness	0.10 – 0.40 mm
Nozzle Diameter	0.40mm
Print Speed	10– 100 cm ³ /h
Print Size	259×207×205mm
Printer Weight	42 lbs. (19 KG) Net 60 lbs. (27 KG) Gross
Printer Size	19.5 × 19.5 × 20.5 in 495 × 495 × 520 mm
Power Requirements	100-240 VAC, 50-60 Hz, 220W

Specifications

Minimum Processor	PC: Intel Core 2 Duo or equivalent Mac: Intel-based only
Operating System Compatibility	PC, 32-bit: Win XP, Vista, 7, 8 PC, 64-bit: Win Vista, 7, 8 Mac, Intel-based: OS 10.6-10.10
Minimum RAM	2GB RAM required
Hard Drive Requirements	500MB available space
Connectivity	USB 2.0
Model Support	Auto-generated Support
Input Format	STL, UP3, UPP

Environmental specifications

Ambient temperature	60°F~85°F
Relative humidity	20%~50%

Technical Support

For technical questions or support issues, contact Afinia Technical Support:

PH: 952-279-2643

support@afinia.com

www.afinia.com

Please have the Model and Serial Number of your Afinia H800+ 3D Printer available when contacting Technical Support.

Date of Purchase:

Place Purchased:

Serial Number:

(Located on back of Printer)

FCC ID: 026-H800+

This device complies with Part 15 of the FCC Rules. Operation is subject to the following two conditions: (1) this device may not cause harmful interference, and (2) this device must accept any interference received, including interference that may cause undesired operation.

Changes or modifications not expressly approved by the party responsible for compliance could void the user's authority to operate the equipment.

NOTE: This equipment has been tested and found to comply with the limits for a Class B digital device, pursuant to Part 15 of the FCC Rules. These limits are designed to provide reasonable protection against harmful interference in a residential installation. This equipment generates, uses, and can radiate radio frequency energy and, if not installed and used in accordance with the instructions, may cause harmful interference to radio communications. However, there is no guarantee that interference will not occur in a particular installation. If this equipment does cause harmful interference to radio or television reception, which can be determined by turning the equipment off and on, the user is encouraged to try to correct the interference by one or more of the following measures:

- Reorient or relocate the receiving antenna.
- Increase the separation between the equipment and receiver.
- Connect the equipment into an outlet on a circuit different from that to which the receiver is connected.
- Consult the dealer or an experienced radio/TV technician for help.